



Food Processor Cutter mixer 2.6 lt with transparent copolyester bowl, variable speed

ITEM # _____

MODEL # _____

NAME # _____

SIS # _____

AIA # _____



602214 (DK26PVSAU)

Cutter mixer 2.6 lt with transparent copolyester bowl, variable speed 500-3600 rpm - Australia

Short Form Specification

Item No. _____

Table top cutter mixer. 2,6 litres, transparent copolyester bowl with scraper and central feed hole for adding products in mid-cycle. Transparent copolyester lid. Microtoothed blade rotor. Angled blades and conical base of the bowl ensure consistent mixing. All ingredients are processed evenly and quickly thanks to a special flow generated inside the bowl. No-volt release system prevents accidental start of the appliance. All parts in contact with food are removable and Dishwasher safe. Waterproof, easy to clean, flat, soft-touch buttons. Variable speed with 9 levels (500 to 3600 rpm) for extra smooth results and emulsifying.

Main Features

- Includes 2,6 liter, transparent bowl with micro-toothed blades rotor.
- Tabletop cutter mixer and emulsifier allowing fast chopping, mixing, mincing, griding, liquidizing and kneading.
- Bowl/lid scraper included for uniform smooth results (emulsifying) and continuous working.
- Transparent lid, with funnel shaped hole, to add ingredients during use.
- All ingredients are processed evenly and quickly thanks to a special movement generated inside the bowl.
- Easy to clean and waterproof control panel with flat on/off button and pulse function.
- Pulse function for coarse chopping.
- All parts in contact with food are removable without the use of tools, completely dismountable and dishwasher safe.
- Productivity up to 50 settings per service.
- 9 speed levels for extra smooth results and high speed emulsifying.

Construction

- Food safety assured in accordance to European directives and UK legislation. In addition, materials in contact with food, are BPA-free.
- Product safety conform to European directives, UK legislation and international health and safety standards.
- Variable speed: 500 - 3600 rpm.
- Motor power: 750 Watt.
- Micro-toothed blades in 420 AISI stainless steel and ergonomic scraper in resistant composite material to ensure consistent mixing.
- compact design, easy to move and store.
- IPX5 (IP55) waterproof, flat, touch-control panel.
- Main switch ON/OFF on the back of the appliance.
- Asynchronous industrial motor with no brushes for high reliability and quiet functioning, stainless steel motor shaft.
- Bowl in BPA-free, transparent copolyester.

APPROVAL: _____



Food Processor Cutter mixer 2.6 lt with transparent copolyester bowl, variable speed

Included Accessories

- 1 of TRANSPARENT LID FOR 2,6LT CUTTER MIXER BOWL PNC 650117
- 1 of MICROTOOTHED BLADE ROTOR FOR 2.6LT CUTTER MIXER PNC 650226
- 1 of TRANSPARENT COPOLYESTER BOWL FOR 2,6 LT CUTTER MIXER PNC 650229
- 1 of SCRAPER FOR 2.6LT CUTTER MIXER BOWL PNC 650230

Optional Accessories

- TRANSPARENT LID FOR 2,6LT CUTTER MIXER BOWL PNC 650117
- TRANSPARENT LID (WITHOUT SEALING) FOR 3,6LT CUTTER MIXER BOWL PNC 650118
- MICROTOOTHED BLADE ROTOR FOR 2.6LT CUTTER MIXER PNC 650226
- SMOOTH BLADE ROTOR FOR 2.6LT CUTTER MIXER PNC 650227
- STAINLESS STEEL BOWL FOR 2,6 LT CUTTER MIXER PNC 650228
- TRANSPARENT COPOLYESTER BOWL FOR 2,6 LT CUTTER MIXER PNC 650229
- SCRAPER FOR 2.6LT CUTTER MIXER BOWL PNC 650230
- STAINLESS STEEL BOWL FOR 2,6LT CUTTER MIXER, MICROTOOTHED ROTOR, LID WITH SCRAPER PNC 650231
- MICROTOOTHED BLADE ROTOR FOR 3.6LT CUTTER MIXER PNC 650233
- SMOOTH BLADE ROTOR FOR 3.6LT CUTTER MIXER PNC 650234
- STAINLESS STEEL BOWL FOR 3.6LT CUTTER MIXER PNC 650235
- SCRAPER FOR 3.6LT CUTTER BOWL PNC 650236
- TRANSPARENT BOWL FOR 2,6LT CUTTER MIXER, MICROTOOTHED ROTOR, LID WITH SCRAPER PNC 650245



Food Processor
Cutter mixer 2.6 lt with transparent copolyester bowl, variable speed
The company reserves the right to make modifications to the products
without prior notice. All information correct at time of printing.

2026.06.16



Food Processor Cutter mixer 2.6 lt with transparent copolyester bowl, variable speed

Front

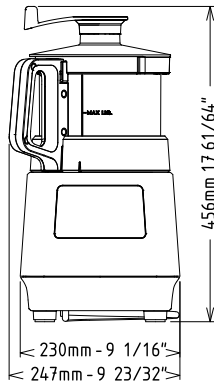

Side

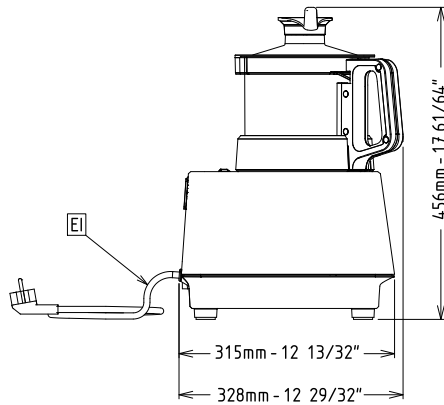

EI = Electrical inlet
(power)

Top

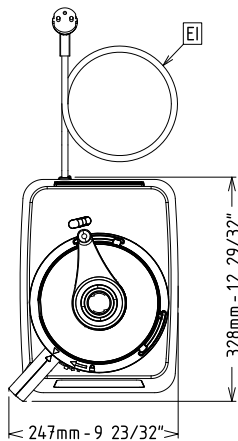

Electric

Supply voltage: 220-240 V/1N ph/50/60 Hz
Electrical power max.: 0.75 kW
Total Watts: 0.75 kW

Capacity:

Performance (up to): 0 kg/Cycle
Capacity: 2.6 litres

Key Information:

External dimensions, Width: 247 mm

External dimensions, Depth: 328 mm

External dimensions, Height: 456 mm

Shipping weight: 18.2 kg

Net weight (kg): 13.6

Cold water paste:

Egg whites:

Food Processor
Cutter mixer 2.6 lt with transparent copolyester bowl, variable speed

The company reserves the right to make modifications to the products
without prior notice. All information correct at time of printing.

